

Jade 52861

4-channel 200 MHz A/D with DDC
3U VPX board with Kintex UltraScale FPGA

Complete radar and software radio interface solution

- Radar and software radio receiver
- Communications receiver
- Analog signal interface for data recording
- Wideband data acquisition
- Remote monitoring
- Sensor interfaces



Jade® 52861 is a multichannel, high-speed data converter with programmable DDCs (digital downconverters). It is suitable for connection to HF or IF ports of a communications or radar system. Its built-in data capture feature offers an ideal turnkey solution as well as a platform for developing and deploying custom FPGA-processing IP.

It includes four A/Ds, a complete multiboard clock and sync section and a large DDR4 memory. In addition to supporting PCI Express Gen. 3 as a native interface, the 52861 includes optional high-bandwidth connections to the Kintex UltraScale FPGA for custom digital I/O.

FEATURES

- Xilinx® Kintex® UltraScale™ FPGA
- Four 200 MHz 16-bit A/Ds
- Four multiband DDCs (digital downconverters)
- 5 GB of 2400 MHz DDR4 SDRAM
- Sample clock synchronization to an external reference
- LVPECL clock/sync bus for multiboard synchronization
- PCI Express interface (Gen. 1, 2 & 3) up to x4
- Optional LVDS port and gigabit serial connections for custom FPGA I/O
- Compatible with VITA-46, VITA-48 and VITA-65 (OpenVPX™ Specification)
- Ruggedized and conduction-cooled versions
- Navigator Design Suite for software and custom IP development

52861 BLOCK DIAGRAM

Click on a block for more information.

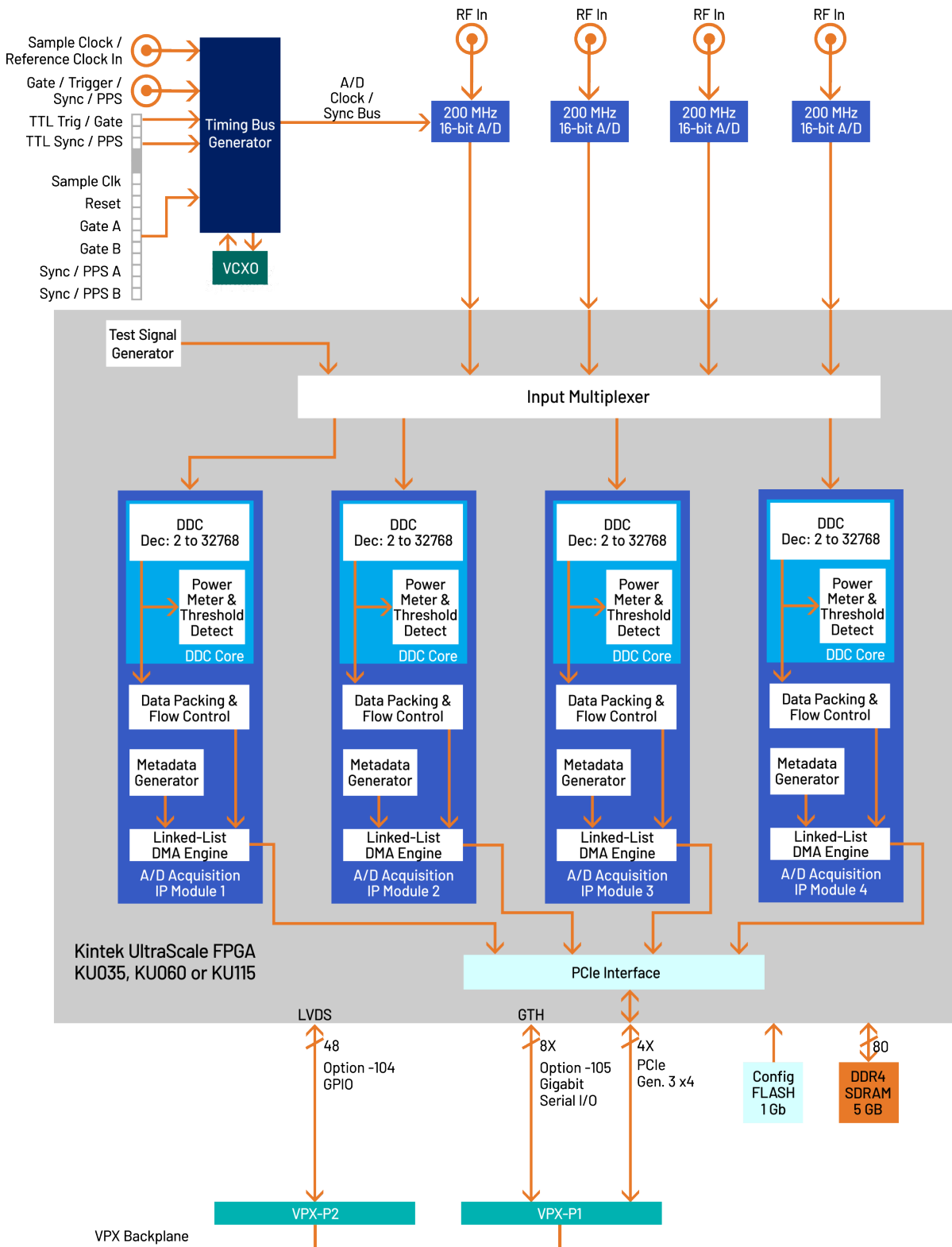

THE JADE ARCHITECTURE

Evolved from the proven designs of Mercury's Cobalt[®] and Onyx[®] families, Jade[®] raises the processing performance while lowering the overall power requirements by building on the Xilinx family of Kintex UltraScale FPGAs. As the central feature of the board architecture, the FPGA has access to all data and control paths, enabling factory-installed functions as well as providing an ideal platform for user-created intellectual property (IP).

Each member of the Jade family is delivered with factory-installed applications ideally matched to the board's analog interfaces. The 52861 factory-installed functions include four A/D acquisition IP modules for simplifying data capture and transfer.

Each of the four acquisition IP modules contains a powerful, programmable DDC IP core; an IP module for DDR4 SDRAM memory; a controller for all data clocking and synchronization functions; a test signal generator; and a PCIe interface. These complete the factory-installed functions and enable the 78862 to operate as a complete turnkey solution for many applications, thereby saving the cost and time of custom IP development.

EXTENDABLE IP DESIGN

For applications that require specialized functions, users can install their own custom IP for data processing. The Navigator[®] FPGA Design Kits include the board's entire FPGA design as a block diagram that can be edited in Xilinx's Vivado tool suite.

In addition to the block diagrams, all source code and complete IP core documentation is included. Developers can integrate their own IP along with the wide range of IP functions contained in the Navigator[®] IP library, or use the Navigator[®] kit to completely replace the IP with their own.

XILINX KINTEX ULTRASCALE FPGAS

Depending on the requirements of the processing task, the Kintex Ultrascale can be selected from a range of FPGAs: KU035 through KU115. The KU115 features 5520 DSP48E2 slices and is ideal for modulation/demodulation, encoding/decoding, encryption/decryption, and channelization of the signals between transmission and reception. For applications not requiring large DSP resources or logic, a lower-cost FPGA can be installed.

A/D CONVERTER STAGE

The board's analog interface accepts four analog HF or IF inputs on front panel SSMC connectors with transformer coupling into four Texas Instruments ADS5485 200 MHz, 16-bit A/D converters. The digital outputs are delivered into the Kintex

UltraScale FPGA for signal-processing or routing to other module resources.

A/D ACQUISITION IP MODULES

The 52861 features four A/D Acquisition IP Modules for easily capturing and moving data. Each IP module can receive data from any of the four A/Ds or a test signal generator.

Each IP module has an associated DMA engine for easily moving A/D data through the PCIe interface. These powerful linked-list DMA engines are capable of a unique Acquisition Gate Driven mode. In this mode, the length of a transfer performed by a link definition need not be known prior to data acquisition; rather, it is governed by the length of the acquisition gate. This is extremely useful in applications where an external gate drives acquisition and the exact length of that gate is not known or is likely to vary.

For each transfer, the DMA engine can automatically construct metadata packets containing A/D channel ID, a sample-accurate time stamp and data length information. These actions simplify the host processor's job of identifying and executing on the data.

DDC IP CORES

Within each A/D Acquisition IP Module is a powerful DDC IP core. Because of the flexible input routing of the A/D Acquisition IP Modules, many different configurations can be achieved including one A/D driving all four DDCs or each of the four A/Ds driving its own DDC.

Each DDC has an independent 32-bit tuning frequency setting that ranges from DC to f_s , where f_s is the A/D sampling frequency. Each DDC can have its own unique decimation setting, supporting as many as four different output bandwidths for the board. Decimations can be programmed from 2 to 32,768 providing a wide range to satisfy most applications.

The decimating filter for each DDC accepts a unique set of user-supplied 18-bit coefficients. The 80% default filters deliver an output bandwidth of $0.8 * f_s / N$, where N is the decimation setting. The rejection of adjacent-band components within the 80% output bandwidth is better than 100 dB. Each DDC delivers a complex output stream consisting of 24-bit I + 24-bit Q or 16-bit I + 16-bit Q samples at a rate of f_s / N .

CLOCKING AND SYNCHRONIZATION

An internal timing bus provides all timing and synchronization required by the A/D converters. It includes a clock, two sync and two gate or trigger signals. An on-board clock generator

receives an external sample clock from the front panel SSMC connector. This clock can be used directly by the A/D or divided by a built-in clock synthesizer circuit.

In an alternate mode, the sample clock can be sourced from an on-board programmable voltage-controlled crystal oscillator. In this mode, the front panel SSMC connector can be used to provide a 10 MHz reference clock for synchronizing the internal oscillator.

A front panel 26-pin LVPECL Clock/Sync connector allows multiple boards to be synchronized. In the slave mode, it accepts LVPECL inputs that drive the clock, sync and gate signals. In the master mode, the LVPECL bus can drive the timing signals for synchronizing multiple modules.

Multiple boards can be driven from the LVPECL bus master, supporting synchronous sampling and sync functions across all connected boards.

MEMORY RESOURCES

The 52861 architecture includes a 5 GB bank of DDR4 SDRAM memory. This resource is used by the board's built-in functions for data storage and buffering, but can also be used for custom applications. The [Navigator](#) FDK provides a memory controller as well as guidance on the most efficient use of the memory when creating IP functions.

PCI EXPRESS INTERFACE

The 52861 includes an industry standard interface fully compliant with PCI Express Gen. 1, 2 and 3 bus specifications. Supporting PCIe links up to x4, the interface includes multiple DMA controllers for efficient transfers to and from the board.

A/D PERFORMANCE

Spurious Free Dynamic Range

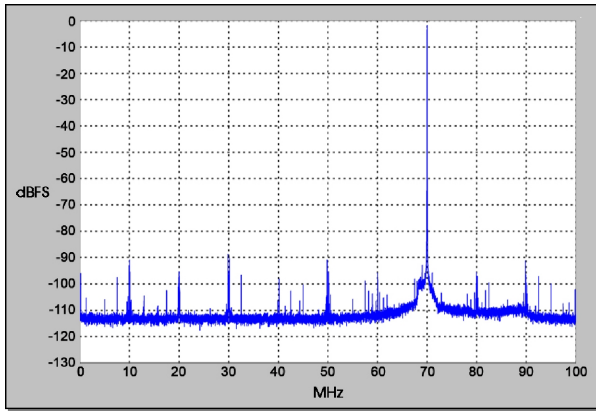

$f_{in} = 70 \text{ MHz}$, $f_s = 200 \text{ MHz}$, Internal Clock

Spurious Pick-up

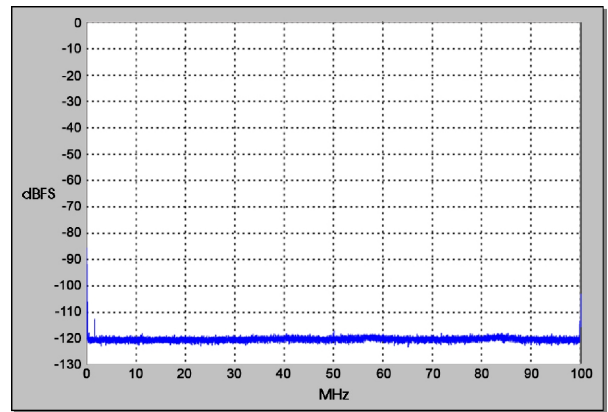

$f_s = 200 \text{ MHz}$, Internal Clock

Two-Tone SFDR

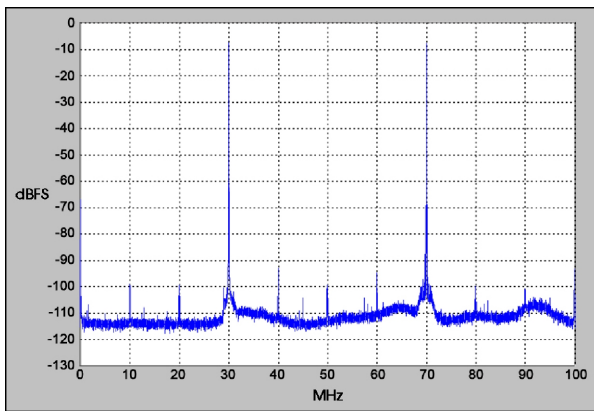

$f_1 = 30 \text{ MHz}$, $f_2 = 70 \text{ MHz}$, $f_s = 200 \text{ MHz}$

Two-Tone SFDR

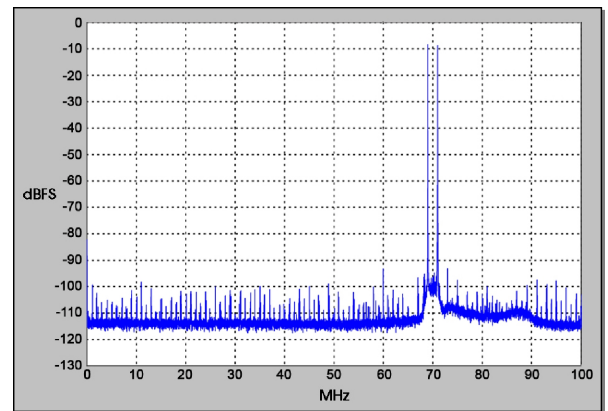

$f_1 = 69 \text{ MHz}$, $f_2 = 71 \text{ MHz}$, $f_s = 200 \text{ MHz}$

Adjacent Channel Crosstalk

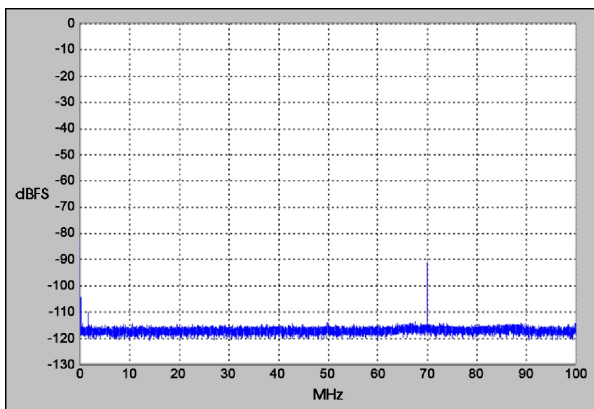

$f_{in} \text{ Ch2} = 70 \text{ MHz}$, $f_s = 200 \text{ MHz}$, Ch 1 shown

Input Frequency Response

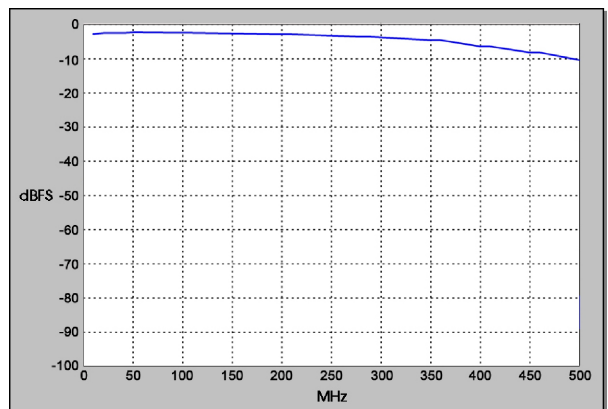

$f_s = 200 \text{ MHz}$, Internal Clock

NAVIGATOR DESIGN SUITE

For applications that require specialized functions, the Navigator Design Suite allows customers to fully utilize the processing power of the FPGA. It includes an FPGA design kit for integrating custom IP into the factory-shipped design, and a board support package for creating host applications for control of all hardware and FPGA IP-based functions.

The **Navigator FPGA Design Kit (FDK)** for the Xilinx® Vivado® Design Suite includes the complete Vivado project folder for each Jade product with all design files for the factory-installed FPGA IP. Vivado’s IP Integrator is a graphical design entry tool that visually presents the complete block diagram of all IP blocks so the developer can access every component of the Jade design. Developers can quickly import, delete, and modify IP blocks and change interconnection paths using simple mouse operations.

Navigator FDK includes an IP core library of more than 100 functions representing a wealth of resources for DSP, data formatting, timing, and streaming operations, all based on the powerful AXI4 standard. multilevel documentation for each IP core is a mouse click away, and fully consistent with Xilinx IP cores.

The **Navigator Board Support Package (BSP)** provides software support for Jade boards. It enables operational control of all hardware functions on the board and IP functions in the FPGA. The BSP structure is designed to complement the functions of the FDK by maintaining a one-to-one relationship between FDK and BSP components. For each IP block found in the FDK library, a matching software module can be found in the BSP. This organization simplifies the creation and editing of software to support new IP functions and modifications to existing IP cores.

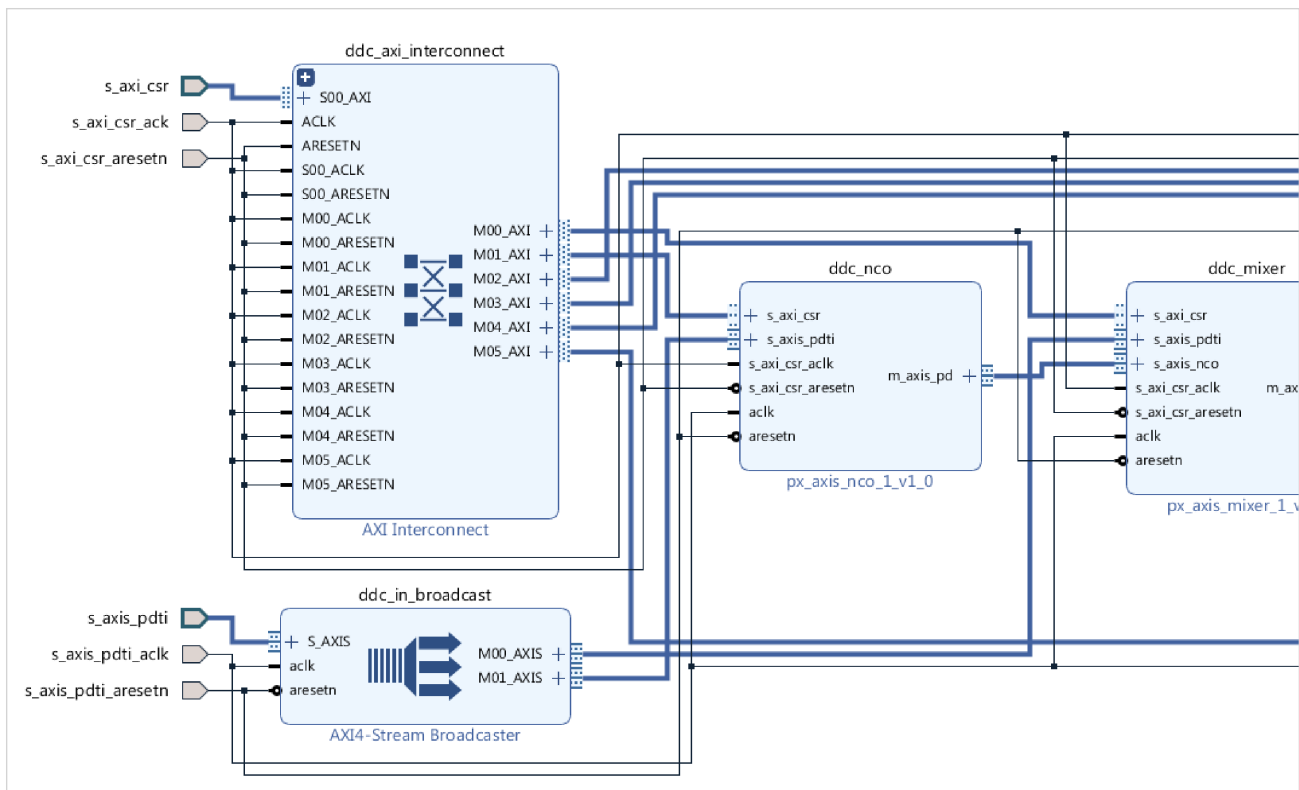

Navigator IP FPGA Design viewed in IP Integrator

NAVIGATOR BOARD SUPPORT PACKAGE

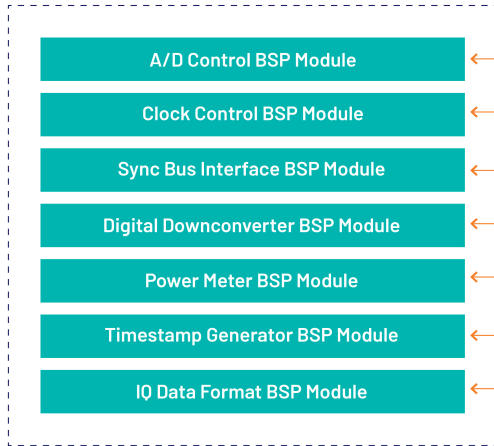

NAVIGATOR FPGA DESIGN KIT

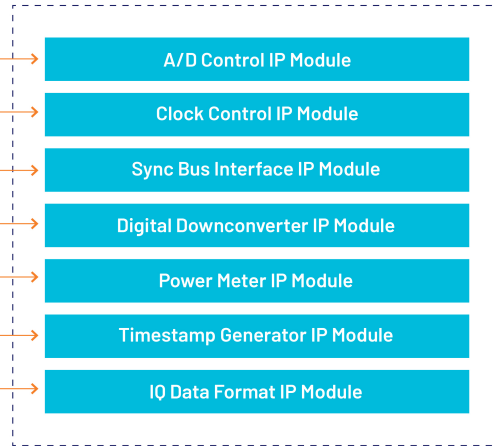

Because all Jade boards are shipped with a full suite of built-in IP functions and numerous software examples, new applications can be developed by building on the provided software examples or built entirely new with the BSP extensive libraries. All BSP libraries are provided as C-language source for full access and code transparency.

The Navigator BSP includes the **Signal Viewer**, a full-featured analysis tool, that displays data in time and frequency domains. Built-in measurement functions display 2nd and 3rd harmonics, THD (total harmonic distortion), and SINAD (signal to noise and distortion). Interactive cursors allow users to mark data points and instantly calculate amplitude and frequency of displayed signals. With the Signal Viewer users can install the Jade board and Navigator BSP and start viewing analog signals immediately.

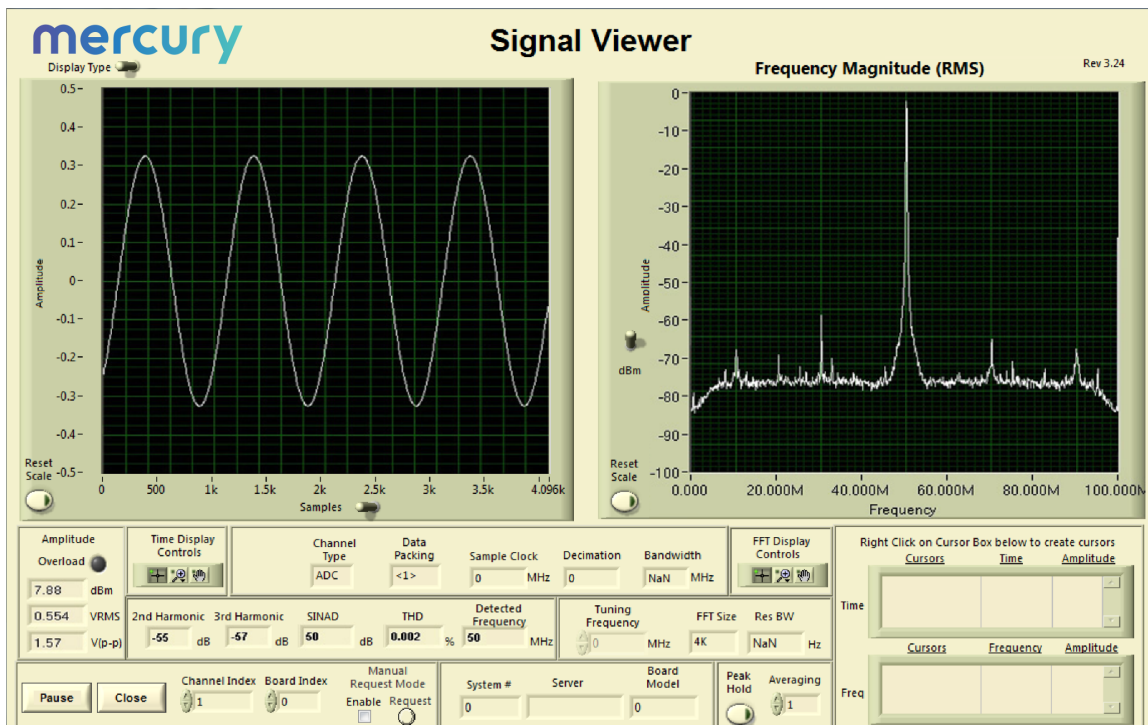

FRONT PANEL CONNECTIONS

The front panel includes six SSMC coaxial connectors for clock, trigger, and analog input signals, and a 26-pin Sync Bus input/output connector. The front panel also includes ten LEDs.

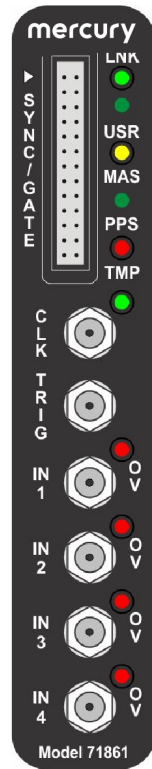

- **Sync Bus Connector:** The 26-pin μ Sync front panel connector, labeled **SYNC/GATE**, provides clock, sync, and gate input/output pins for the LVPECL Sync Bus.
- **Link LED:** The green **LNK** LED indicates the link speed when a valid link has been established over the PCIe interface, as follows: Gen 1 - LED blinks slowly (less than once per second); Gen 2 - LED blinks about once per second; Gen 3 - LED will be constantly on.
- **User LED:** The green **USR** LED is for user applications.
- **Master LED:** The yellow **MAS** LED illuminates when this 71861 is the Sync Bus Master. When only a single 71861 is used, it must be a Master.
- **PPS LED:** The green **PPS** LED illuminates when a valid PPS signal is detected. The LED will blink at the rate of the PPS signal.
- **Over Temperature LED:** The red **TMP** LED illuminates when an over-temperature or over-voltage condition is indicated by any of the temperature/voltage sensors on the 71861 PCB.
- **Clock LED:** The green **CLK** LED illuminates when a valid sample clock signal is detected. If the LED is not illuminated, no clock has been detected and no data from the input stream can be processed.
- **Clock Input Connector:** One SSMC coaxial connector, labeled **CLK**, for input of an external sample clock.
- **Trigger Input Connector:** One SSMC coaxial connector, labeled **TRIG**, for input of an external trigger.
- **Analog Input Connectors:** Four SSMC coaxial connectors, labeled **IN 1**, **IN 2**, **IN 3**, and **IN 4**: one for each ADS5485 input channel.
- **A/D Overload LEDs:** There are four red **OV** (overload) LEDs: one for each A/D input. Each LED indicates either an analog input overload in the associated ADS5485, or an A/D FIFO overrun.

SPECIFICATIONS

Front Panel Analog Signal Inputs

Input Type: Transformer-coupled, front panel female MMCX connectors

Transformer Type: Coil Craft WBC4-6TLB

Full Scale Input: +4 dBm into 50 ohms

3 dB Passband: 300 kHz to 700 MHz

A/D Converters

Type: Texas Instruments ADS5485

Sampling Rate: 10 MHz to 200 MHz

Resolution: 16 bits

Digital Downconverters

Quantity: Four channels

Decimation Range: 2x to 32,768x in three stages of 2x to 32x

LO Tuning Freq. Resolution: 32 bits, 0 to f_s

LO SFDR: >120 dB

Phase Offset Resolution: 32 bits, 0 to 360 degrees

FIR Filter: 24-bit coefficients, 24-bit output, user-programmable coefficients

Default Filter Set: 80% bandwidth, <0.3 dB passband ripple, >100 dB stopband attenuation

Sample Clock Sources

On-board clock synthesizer

Clock Synthesizer

Clock Source: Selectable from on-board programmable VCXO (10 to 810 MHz), front panel external clock or LVPECL timing bus

Synchronization: VCXO can be locked to an external 4 to 180 MHz PLL system reference, typically 10 MHz

Clock Dividers: External clock or VCXO can be divided by 1, 2, 3, 4, 6, 8, or 16 for the A/D clock

External Clock

Type: Front panel female SSMC connector, sine wave, 0 to +10 dBm, AC-coupled, 50 ohms, accepts 10 to 800 MHz divider input clock or PLL system reference

Timing Bus

26-pin connector LVPECL bus includes, clock/sync/gate/PPS inputs and outputs; TTL signal for gate/trigger and sync/PPS inputs

External Trigger Input

Type: Front panel female SSMC connector, LVTTTL
 Function: Programmable functions include: trigger, gate, sync and PPS

Field Programmable Gate Array

Standard: Xilinx Kintex UltraScale XCKU035-2

- Option -084: Xilinx Kintex UltraScale XCKU060-2
- Option -087: Xilinx Kintex UltraScale XCKU115-2

Custom I/O

Option -104: provides 24 pairs of LVDS connections between the FPGA and the VPX P2 connector for custom I/O.
 Option -105: installs the XMC P16 connector with one 8X gigabit serial link to the FPGA

Memory

Type: DDR4 SDRAM
 Size: 5 GB
 Speed: 1200 MHz (2400 MHz DDR)

PCI-Express Interface

PCI Express Bus: Gen. 1, 2 or 3: x4

Environmental

Standard: L0 (air-cooled)

- Operating Temp: 0° to 50° C
- Storage Temp: -20° to 90° C
- Relative Humidity: 0 to 95%, non-condensing

Option -702: L2 (air-cooled)

- Operating Temp: -20° to 65° C
- Storage Temp: -40° to 100° C
- Relative Humidity: 0 to 95%, non-condensing

Option -763: L3 (conduction-cooled)

- Operating Temp: -40° to 70° C
- Storage Temp: -50° to 100° C
- Relative Humidity: 0 to 95%, non-condensing

Physical

Dimensions: VPX board

- Depth: 170.61 mm (6.717 in)
- Height: 100 mm (3.937 in)

Weight: Approximately 14 oz (400 grams)

ORDERING INFORMATION

Model	Description
52861	4-channel 200 MHz A/D with DDCs and Kintex UltraScale FPGA - 3U VPX

Options:	
-084	XCKU060-2 FPGA
-087	XCKU115-2 FPGA
-104	LVDS FPGA I/O through P14 connector
-105	Gigabit serial FPGA I/O
-702	Air-cooled, Level 2
-763	Conduction-cooled, Level 3

Contact Mercury for compatible option combinations and complete specifications of rugged and conduction-cooled versions. Options may change, so be sure to contact Mercury for the latest information.

ACCESSORY PRODUCTS

Model	Description
2171	Cable Kit: SSMC to SMA

DEVELOPMENT SYSTEMS

Mercury offers development systems for Jade products. They come with all pre-tested software and hardware ready for immediate operation. These systems are intended to save engineers and system integrators the time and expense associated with building and testing a development system that ensures optimum performance of Jade boards. Please [contact Mercury](#) to configure a system that matches your requirements.

FORM FACTORS

Jade products are available in standard form factors including 3U VPX, 6U VPX, PCIe, and XMC. The Jade Model 71861 XMC (4-Channel 200 MHz A/D with Multiband DDCs, Kintex UltraScale FPGA) has the following variants:

Model	
52861	3U VPX board (single XMC)
54861	3U VPX board (single XMC with optical/backplane RF)
57861	6U VPX board (single XMC)
58861	6U VPX board (dual XMC)
71861	XMC module
78861	PCIe board (single XMC)

LIFETIME SUPPORT FOR JADE PRODUCTS

Mercury offers worldwide customers shorter development time, reliable, rugged solutions for a variety of environments, reduced costs, and mature software development tools. We offer free lifetime support from our engineering staff, which customers can depend on through phone and email, as well as software updates. Take advantage of our 40 years of experience in delivering high-performance radar, communications, SIGINT, EW, and data acquisition MIL-Aero solutions worldwide.



Corporate Headquarters

50 Minuteman Road
 Andover, MA 01810 USA
+1 978.967.1401 tel
+1 866.627.6951 tel
+1 978.256.3599 fax

International Headquarters

Mercury International
 Avenue Eugène-Lance, 38
 PO Box 584
 CH-1212 Grand-Lancy 1
 Geneva, Switzerland
+41 22 884 5100 tel

Learn more

Visit: mrcy.com/go/MP52861

For technical details, contact:
mrcy.com/go/CF52861



The Mercury Systems logo and the following are trademarks or registered trademarks of Mercury Systems, Inc.: Mercury Systems, Innovation That Matters, Jade and Navigator. Other marks used herein may be trademarks or registered trademarks of their respective holders. Mercury believes this information is accurate as of its publication date and is not responsible for any inadvertent errors. The information contained herein is subject to change without notice.

