

Model
2586

200 MS/sec RF/IF, 1/2 ATR

Talon RTX
Extreme Recorder

Small Form
Factor

Features

- Rugged 1/2 ATR MIL-spec chassis for harsh mechanical and thermal environments
- Environmentally sealed
- Internally conduction-cooled
- Fully sealed for RF emissions with EMI power line filter
- MIL-STD circular connectors
- Compact and lightweight: 18 lb (8 kg)
- QuickPac® drive packs allow quick removal of all data storage via the front panel
- Ideal for UAVs, military vehicles, aircraft pods and outdoor environments
- RF/IF recording with phase coherent 200 MHz 16-bit A/Ds and DDCs
- Sustained real-time record rates up to 4 GB/s
- 12 to 28 VDC power supply
- Optional GPS receiver for precise time and position stamping
- SystemFlow API, GUI and Signal Viewer analysis tools

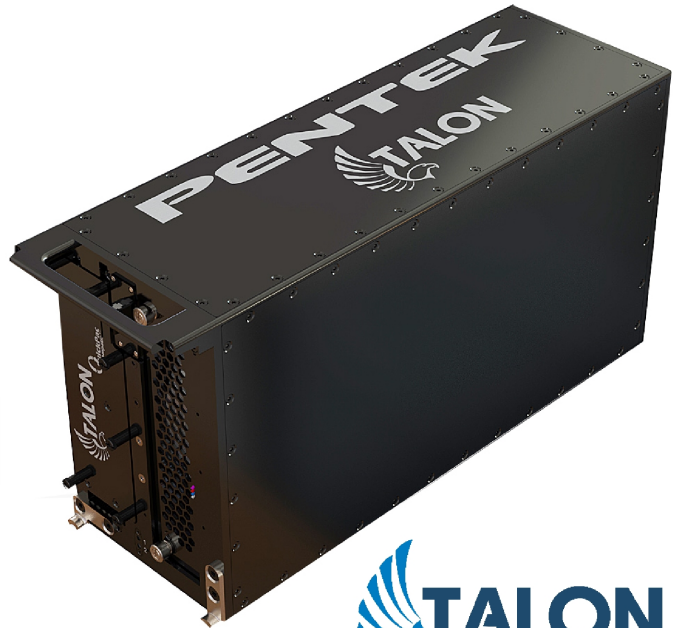

General Information

Pentek's Talon RTX Small Form Factor (SFF) recorders provide the performance of large rackmount recorders in the smallest footprint available in Pentek's Talon Recording System product line. Packaged in an extremely rugged 1/2 ATR form factor, these recorders provide high-performance processing, high speed data storage and large solid state storage capacity.

Optimized for SWaP (size, weight and power), Talon RTX SFF recorders are packaged in a 1/2 ATR footprint, measuring 7.688" H x 4.880" W x 14.125" D and weighing only 18 pounds (8 kg). These recorders are capable of sustained real-time recording speeds up to 4 GB/s and can hold up to 61 TB of SSD storage. A standard system will draw approximately 115 W at full operation.

The Model RTX 2586 provides up to four phase-coherent channels of 200 MHz 16-bit A/Ds, allowing users the ability to capture up to 80 MHz of RF/IF signal bandwidth per channel with excellent dynamic range. It can sample RF/IF signals up to 700 MHz and provides digital downconverters with selectable decimation to 32k.

The RTX 2586 provides optional playback via 800 MHz 16-bit D/As with matching digital upconversion and interpolation.

2586 Block Diagram

FRONT PANEL

REAR PANEL

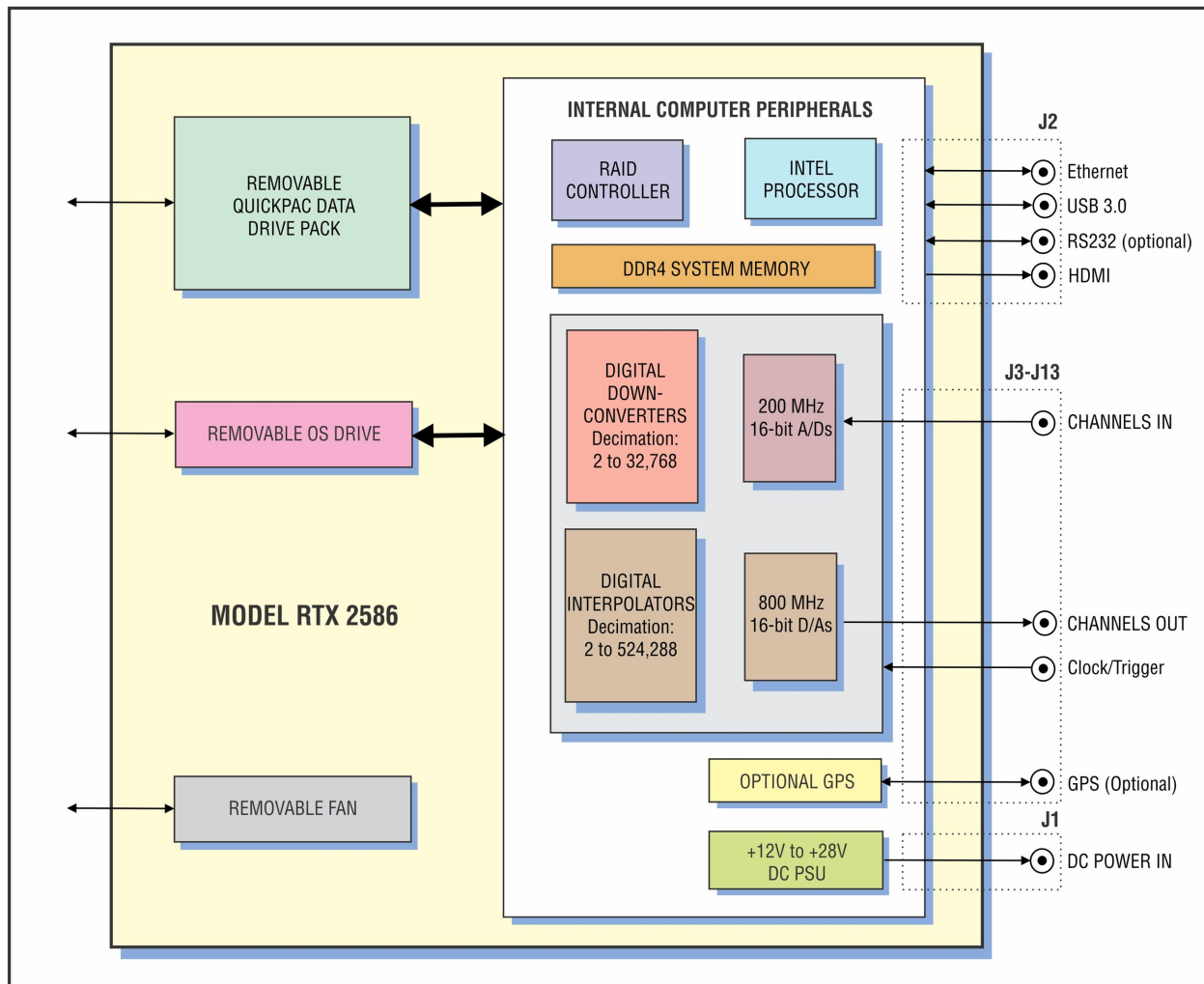

Extremely Rugged Design

Designed to operate in the toughest environments, the recorder chassis keeps all electronics sealed from the outside environment and removes heat by conducting to forced-air cooling channels. Designed to operate from -40° to $+60^{\circ}$ C, these recorders can operate in most thermal environments, making them ideal for UAVs, aircraft pods, tight equipment bays, military vehicles and most outdoor environments.

The sealed $\frac{1}{2}$ ATR chassis uses MIL-STD circular connectors for I/O to control RF emissions while protecting the recorder's electronics from humidity, water, dust, sand and salt fog. In addition to meeting MIL-STD 461 specifications for radiated RF emissions, conducted emission military specifications are met by design with a built-in conducted emissions filter.

Designed to handle high levels of shock and vibration, this extremely rugged chassis supports Pentek's extensive line of I/O front-ends, providing multichannel, wide bandwidth RF recording and a variety of digital interface recording options. An optional GPS receiver provides precise time stamping of recordings and can track and record the GPS position of the system during operation.

QuickPac Drive Packs

The Pentek QuickPac drive packs add a valuable convenience to the RTX SFF 1/2 ATR recorder by providing the ability to quickly remove all data storage from the recorder via the front panel. With up to 61 TB of solid-state data storage capacity, QuickPac drive packs can be easily removed from the recorder by loosening a set of captive thumb screws. A separate operating system drive can be removed as well, allowing users to extract all non-volatile memory from the system in just a few seconds.

QuickPac drive packs include a high insertion cycle connector to provide an extremely durable data storage drive for Talon recorders. Spare QuickPac drive packs can replace full ones in seconds to minimize mission downtime. QuickPac drive packs filled with mission data can be taken to the lab where data can be retrieved, post-processed and archived with a Talon offload system.

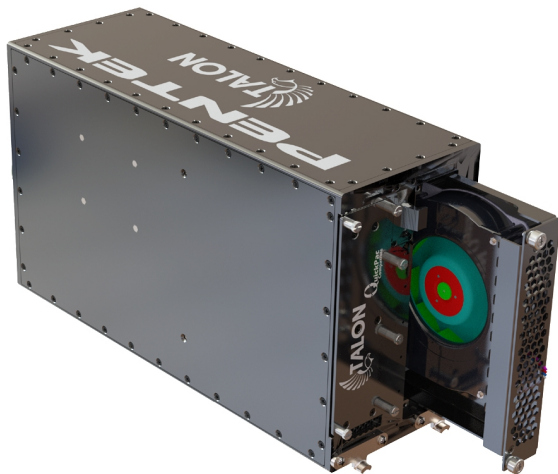

Sealed Chassis with Cooling Design

The Talon RTX SFF chassis seals the internal electronics from the outside environment by providing an inner plenum that is designed to extract heat from the internal electronics via conduction. The plenum is supplemented by a removable fan that is used to pull air from the front of the chassis and exhaust it through the rear. Only the fan is exposed to the outside environment, assuring the electronics are protected in the sealed chassis. The removable fan pulls air from the front of the chassis across heat sinks that are welded to the inner plenum of the chassis.

The welded heat sinks are attached directly to all heat-generating electronics within the sealed chassis, providing a conduction-cooled path to the inner plenum. This assures optimal cooling while maintaining a sealed design. The inner plenum can be replaced to provide other cooling options, such as liquid or conduction cooling.

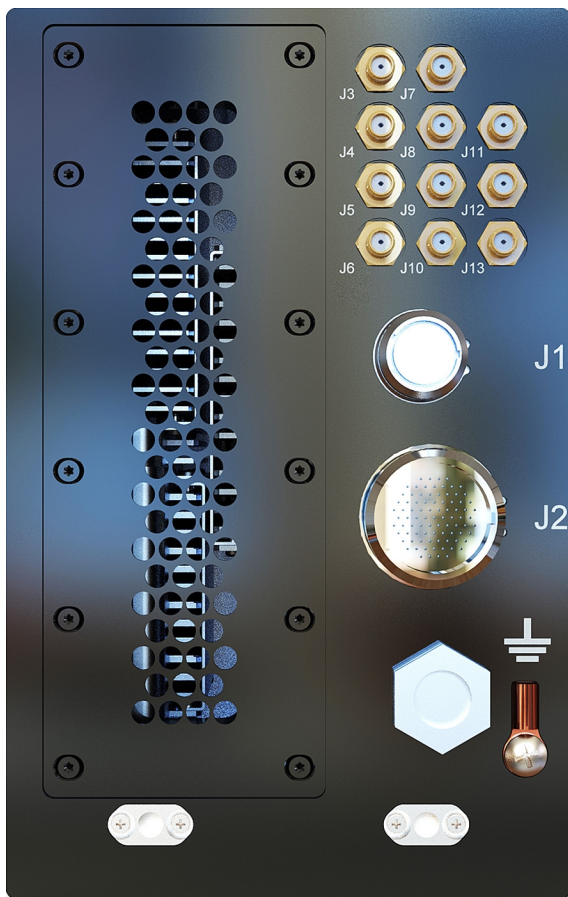

Rear Panel I/O

The Talon RTX SFF rear panel I/O provides circular connectors for power and computer I/O. Bulkhead mounted SMA connectors for RF signals, GPS, clocks and triggers are sealed with gaskets for moisture and RF emissions protection. Optical I/O is provided via an optional rear panel connection.



SystemFlow Software

All Talon recorders include the Pentek SystemFlow[®] recording software. SystemFlow features a Windows-based GUI (Graphical User Interface) that provides a simple means to configure and control the recorder. SystemFlow's client/server architecture allows the real-time recording software to run on the Talon recorder independently of the control software, which can run on an external computer.

System engineers can use the SystemFlow GUI to control the system remotely or develop a custom interface using the [SystemFlow API](#) (Application Programming Interface). Remote control takes place over gigabit Ethernet. Recordings are kept simple to allow for extremely high bandwidth data storage, streaming only the raw data to disk.

A simple header that holds the recording parameters is added to the beginning of the file. An optional GPS receiver allows the user to precisely timestamp files and optionally track the recorder's position throughout a mission. The system records all data to the native NTFS file system, allowing for quick and easy access to the data from any computer.

SystemFlow Main Interface

The RTX 2586 GUI shows a block diagram of the system and provides the user with a control interface for the recording system. It includes Configure, Record, Playback, and Status screens, each with intuitive controls and indicators. The user can easily move between screens to configure parameters, control and monitor a recording, and play back a recorded stream.

Profile Configuration

Load Profile

Save Profile

Remote Server Configuration

Server Name:

DNS Name/IP Address:

Connect

Local

78621_1

Pentek Model 78621

Channel	Channel Parameters	Board Status
CH1 IN	<input type="button" value="Configure"/>	Temperature: 64 °C
CH2 IN	<input type="button" value="Configure"/>	+12V: 12.0 V
		+3.3V: 3.25 V
CH1 OUT	<input type="button" value="Configure"/>	+2.5V: 2.48 V
		+1.8V: 1.79 V
		+1.5V: 1.48 V

CDC Lock Status Clock:

MODEL RTX 2586

INTERNAL COMPUTER PERIPHERALS

- REMOVABLE QUICKPAC DATA DRIVE PACK
- REMOVABLE OS DRIVE
- REMOVABLE FAN
- RAID CONTROLLER
- INTEL PROCESSOR
- DDR4 SYSTEM MEMORY
- DIGITAL DOWN-CONVERTERS (Decimation: 2 to 32,768)
- 200 MHz 16-bit A/Ds
- DIGITAL UPCONVERTERS (Interpolation: 2 to 524,288)
- 800 MHz 16-bit D/As
- OPTIONAL GPS
- +12V to +28V DC PSU

Connectors:

- J2: Ethernet, USB 3.0, RS232, HDMI
- J3-J13: CHANNELS IN, CHANNELS OUT, Clock/Trigger
- J1: GPS (Optional), DC POWER IN

SystemFlow Hardware Configuration Interface

The RTX 2586 Configure screens provide a simple and intuitive means for setting up the system parameters. The Channel 1 Input Parameters configuration screen shown here provides entries for input source, center frequency, decimation, as well as gate and trigger information. All parameters contain limit-checking and integrated help to provide an easier-to-use out-of-the-box experience.

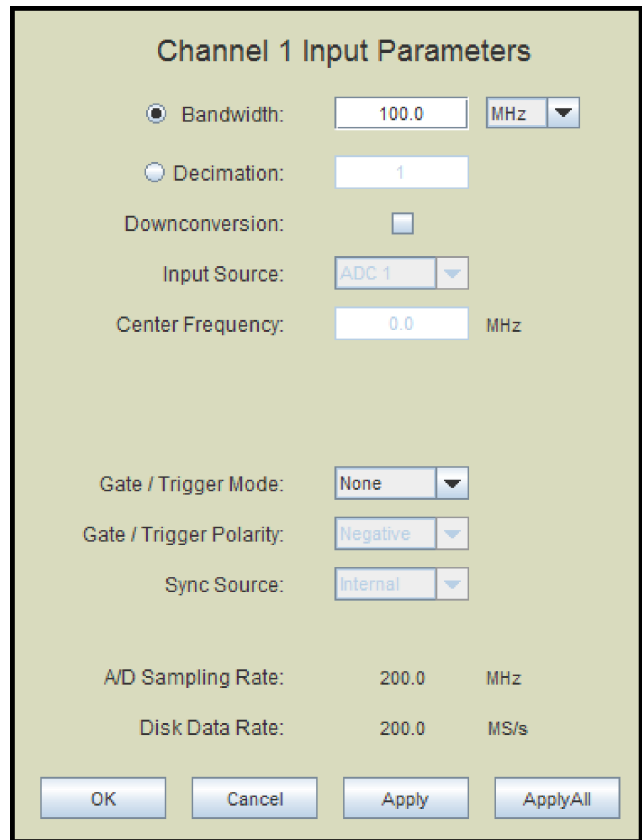

SystemFlow Recorder Interface

The Record screen allows users to browse to a folder and enter a file name for the recording. The length of the recording for each channel can be specified in megabytes or in seconds. Intuitive buttons for Record, Pause and Stop simplify operation. Status indicators for each channel display the mode, the number of recorded bytes, and the average data rate. A Data Loss indicator alerts the user to any problem, such as a disk full condition.

By checking the Master Record boxes, any combination of channels in the lower screen can be grouped for synchronous recording via the upper Master Record screen. The recording time can be specified, and monitoring functions inform the operator of recording progress.

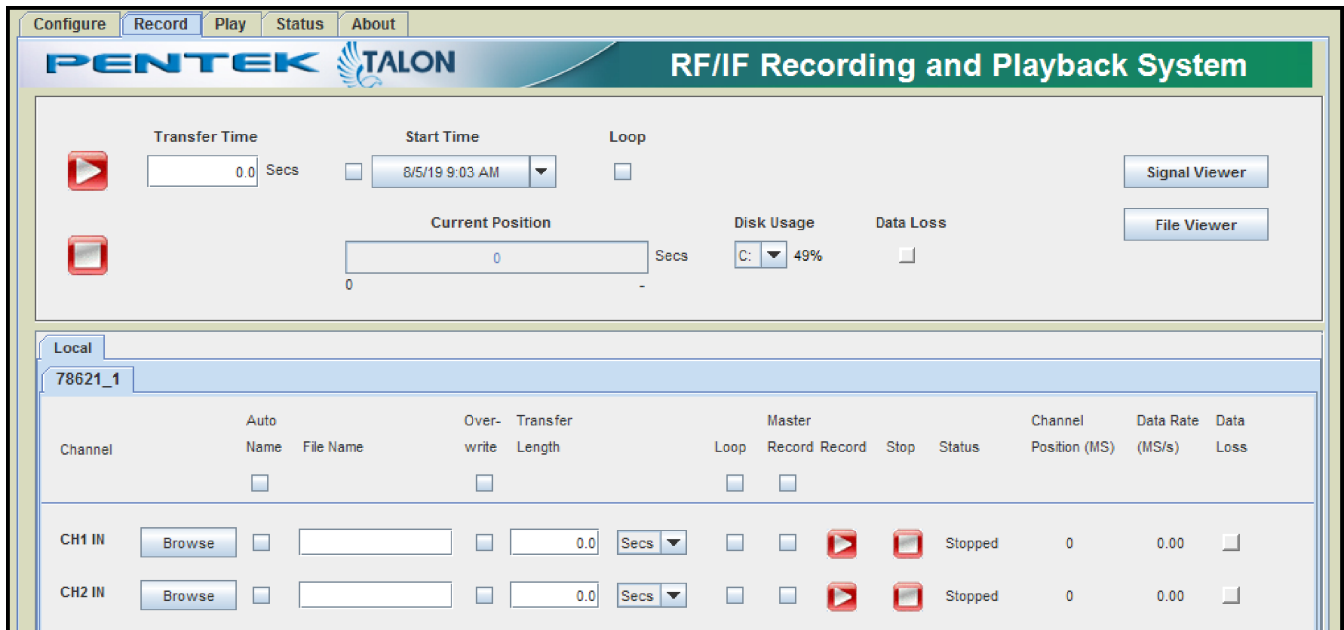

SystemFlow Signal Viewer

The SystemFlow Signal Viewer includes a virtual oscilloscope and spectrum analyzer for signal monitoring in both the time and frequency domains. It is extremely useful for previewing live inputs prior to recording, and for monitoring signals as they are being recorded to help ensure successful recording sessions. The viewer can also be used to inspect and analyze the recorded files after the recording is complete.

Advanced signal analysis capabilities include automatic calculators for signal amplitude and frequency, second and third harmonic components, THD (total harmonic distortion), and SINAD (signal to noise and distortion). With time and frequency zoom, panning modes, and dual, annotated cursors to mark and measure points of interest, the SystemFlow Signal Viewer can often eliminate the need for a separate oscilloscope or spectrum analyzer in the field.

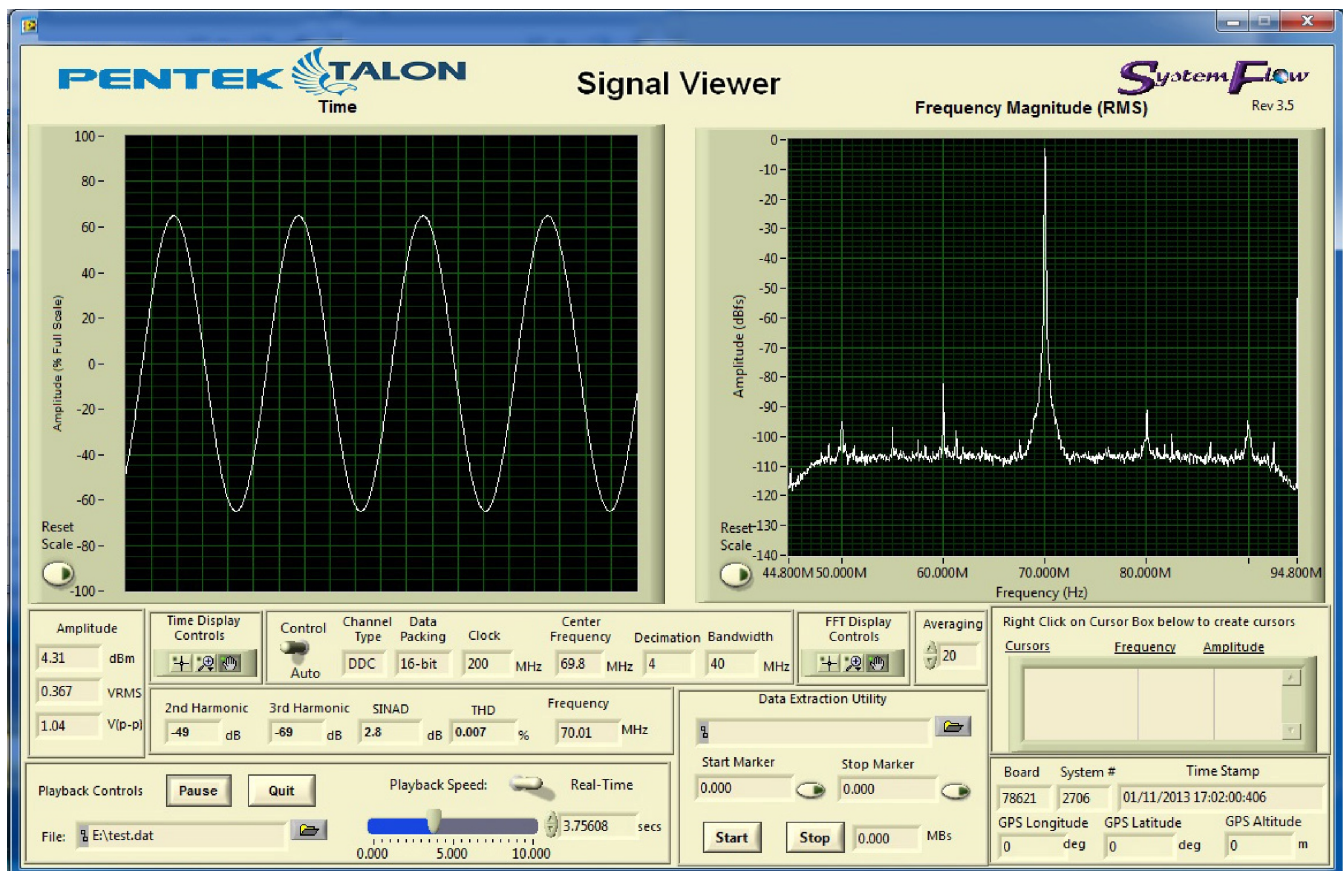

SystemFlow Simulator

To learn more about the SystemFlow Software, you can [download and install the free SystemFlow Simulator](http://pentek.com/systemflow/systemflow.cfm#SystemFlowSimulator) to your desktop or laptop PC (pentek.com/systemflow/systemflow.cfm#SystemFlowSimulator).

The [SystemFlow Simulator](#) allows you to learn how to use the Talon recording system's SystemFlow software interface before you acquire a recorder or while you are waiting for delivery of a Talon recording system. The Simulator can simulate the operating environment of all the different Talon recorder models. The Simulator also demonstrates the [SystemFlow Signal Viewer](#) by playing recorded signals to simulate the appearance of live signals being digitized and recorded by a Pentek analog signal recorder.

Specifications

Physical Characteristics

Dimension: 7.688" H x 4.880" W x 14.125" D (195 mm H x 124 mm W x 359 mm D)

Weight: 18 lb (8 kg)

Storage: One removable QuickPac® with up to 61 TB total storage

RAID Levels: 0, 5 and 6 available

One removable Operating System SSD (M.2 form factor - 250 GB standard)

Front Panel I/O

One removable QuickPac (Thumbscrew removable)

One removable Operating System SSD (Thumbscrew removable)

One removable System Fan (Thumbscrew removable)

Rear Panel I/O

Chassis power connector: Glenair 805-005-07M12-2PA

Mating cable power connector: Glenair 805-002-16M12-2SA

Computer I/O

Chassis Computer I/O Connector: Glenair 805-003-07M19-85SA

Signals, 1 each: HDMI, USB 3.0, Ethernet (RJ 45), RS232

Mating cable computer I/O Connector: Glenair 802-002-16M19-85PA

RF: 11x SMA (female SMA bulkhead-mounted with gas-kets)

Cooling

Conduction-cooled to inner air channel

Removable fan inserted in air channel to pull air across sealed heat sinks

Optional direct conduction cooling and other methods available

Power

+12 to +28 VDC (+24 VDC nominal) 125 Watts power consumption typical, 170 W maximum

Analog Signal Inputs

Connectors: Female bulkhead SMA connectors

Input Type: Transformer Coupled (DC-coupled option available)

Transformer Type: Coil Craft WBC4-6TLB

Type: Texas Instruments ADS5485

Sampling Rate (f_s): 10 MHz to 200 MHz

Resolution: 16 bits

SNR: 75 dBFS Typ. @ 70 MHz

SFDR: 87 dBc Typ. @ 70 MHz

Full Scale Input: +8 dBm into 50 ohms

3 dB Passband: 300 kHz to 700 MHz

Anti-Aliasing Filters: External, user-supplied

Digital Downconverters

Decimation: 2 to 32,768

IF Center Frequency Tuning: DC to f_s , 32 bits

LO SFDR: >120 db

DDC Usable Bandwidth: $0.8 * f_s / D$

Analog Signal Outputs

Connectors: Female bulkhead SMA connectors

Input Type: Transformer Coupled

Transformer Type: Coil Craft WBC4-6TLB

Full Scale Output: +4 dBm into 50 ohms

3 dB Passband: 300 kHz to 700 MHz

D/A Converters

Type: Texas Instruments DAC5688

Input Data Rate to DAC5688: 250 MS/sec max.

Output Sampling Rate: 800 MHz max

Resolution: 16 bits

Digital Upconverters

Interpolation: 2 to 524,288

Output IF: DC to 400 MHz

Bandwidth Range: Matches recording bandwidths

Clock Sources

Source: selectable from onboard programmable VCXO, or external clock

External Clock Connector: Female bulkhead SMA connector

External Clock Signal Requirement: Sine wave 0 dBm to 10 dBm full scale

External Trigger

External Trigger Connector: Female bulkhead SMA

External Trigger Signal Requirement: TTL

Processor and Memory

Processor: Intel Core i7, 7700K, 7th Generation, Quad Core, 4.2 GHz

DRAM: 8 GB DDR 4, optional 16 to 32 GB

Environmental

Operating Temp: -40° to +60° C (-20° C start-up)

Storage Temp: -65° to +85° C

Altitude: 60,000 feet

Relative Humidity: 5 to 95%, condensing

Vibration: MIL-STD-810 Method 514.5

Shock: MIL-STD-810 Method 516.5

EMI/EMC: MIL-STD-461 - CE101, CE102, CS101, RE101, RE102, RS101

Sand and Dust: MIL-STD-810 Method 510

Ordering Information

Click [here](#) for more information.

Storage Options	
Option -410	3.84 TB SSD storage capacity
Option -415	7.68 TB SSD storage capacity
Option -420	15.36 TB SSD storage capacity
Option -430	30.72 TB SSD storage capacity
Option -460	61 TB SSD storage capacity
RAID Configurations	
Standard	RAID Level 0
Option -285	RAID Level 5
Option -286	RAID Level 6
Channel Configurations	
Option -201	1 Channel recording
Option -202	2 Channel recording
Option -203	3 Channel recording
Option -204	4 Channel recording
Option -221	1 Channel playback
Option -222	2 Channel playback
Option -224	4 Channel playback
Note: Record and playback interfaces not available together.	
Additional Options	
Option -261	GPS time and position stamping
Standard	8 GB DDR System Memory
Option -309	16 GB DDR System Memory
Option -310	32 GB System Memory
Contact Pentek for compatible Option combinations. Storage and General Options may change, contact Pentek for latest information.	

Accessory Products

Power Cable	
Part Number:	2182-102
Length:	3 feet
MIL-STD Connector:	Glenair 805-002-16M12-2SA
Leads:	Two 14-gauge wires, unterminated

Computer I/O Breakout Cable	
Part Number:	2182-202
Length:	3 feet
MIL-STD Connector:	Glenair 805-002-16-M19-85PA
Breakout connectors (1 each):	HDMI female, USB 3.0 female, RJ45 female, power button, reset button

1/2 ATR Tray	
Part Number:	8380-258
Dimensions	15" L x 5.01" W x 1.223" H
Material:	.063 6061-T6 aluminum
Finish:	Chem Film per MIL-DTL-5541F, Type 1, Class 3

Spare QuickPac Drive Pack	
Part Number:	8336
Capacities:	Option 615: 7.6 TB
	Option 620: 15.3 TB
	Option 625: 30.7 TB

Lifetime Support

Pentek offers the worldwide military embedded computing community shorter development time, reliable, rugged solutions for a variety of environments, reduced costs, mature software development tools, and **free** lifetime support that our customers can depend on: phone and email access to engineering staff as well as software updates. Take advantage of Pentek's expertise in delivering high-performance radar, communications, SIGINT, and data acquisition MIL-Aero solutions worldwide for over 30 years.

Pricing and Availability

To learn more about our products or to discuss your specific application please contact [your local representative](#) or Pentek directly:

Pentek, Inc.
 One Park Way
 Upper Saddle River, NJ 07458 USA
 Tel: +1 (201) 818-5900
 Email: sales@pentek.com